

# Data Sheet

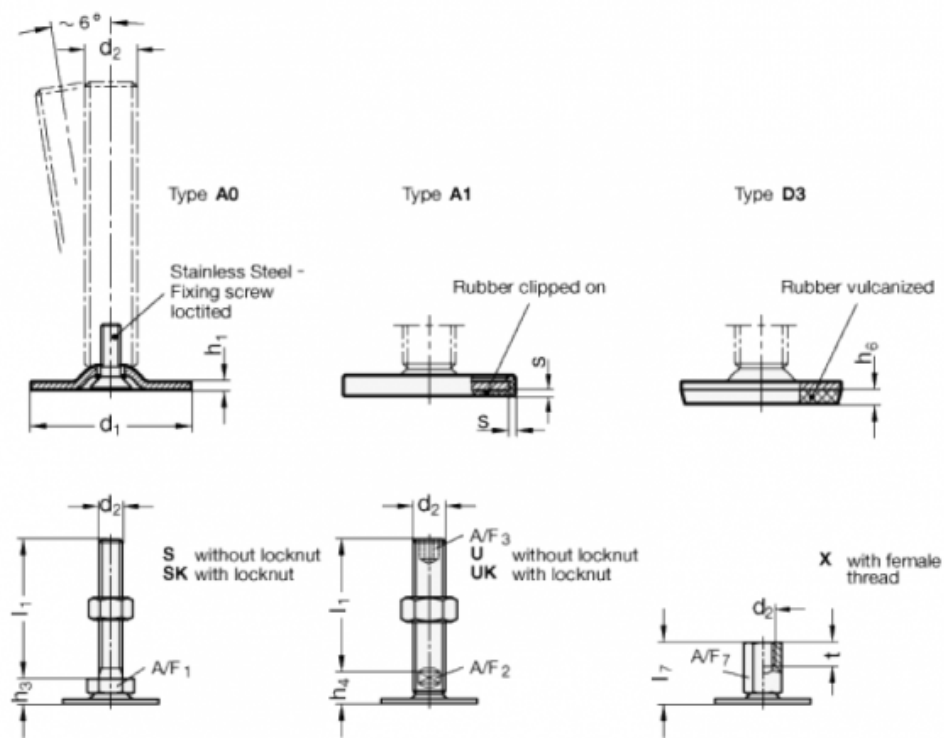

Article number: 204040M1050A3SK  
 Description: E+G levelling foot  
 GN 40-40-M10-50-A3-SK  
 Note: SK With nut, External hexagon at the bottom

## Measures



- A/F1 = 17
- d1 = 40
- d2 = M10
- h1 = 2
- h3 = 11
- h6 = 3.5
- l1 = 50
- s =